

# Translation Word Meaning

Martin Kay

Stanford University

Martin Kay

Translation—Meaning

1

## Major Topics

1. Introduction
2. Meaning
3. Situated language
4. Processing morphology and syntax
5. Transfer and Interlingua
6. Difficulties for man and machine
7. MT Practice
8. Language and statistics
9. (Language learning)

Martin Kay

Translation—Meaning

2

## Semantics

The study of meaning

- Lexical Semantics—the meaning of words (and other lexical items)
- Compositional semantics—deriving the meanings of larger units from the meanings of their constituents

Martin Kay

Translation—Meaning

3

## Some Dimensons

Signifiant	↔	Signifié	(Sausure)
Sense	↔	Reference	(Russell)
connotation	↔	denotation	
Sinn	↔	Bedeutung	(Frege)
Intension	↔	Extension	
Langue	↔	Parole	
Competence	↔	Performance	(Chomsky)
Syntagmatic	↔	Paradigmatic	
Descriptive	↔	Prescriptive	
Synchronic	↔	Diachronic	

Martin Kay

Translation—Meaning

4

## Some Dimensions

<b>Signifiant</b>	↔	<b>Signifié</b> ( <i>Sausure</i> )
<b>Sense</b>	↔	<b>Reference</b> ( <i>Russell</i> )
<b>connotation</b>	↔	<b>denotation</b>
<b>Sinn</b>	↔	<b>Bedeutung</b> ( <i>Frege</i> )
<b>Intension</b>	↔	<b>Extension</b>
<b>Langue</b>	↔	<b>Parole</b>
<b>Competence</b>	↔	<b>Performance</b> ( <i>Chomsky</i> )
<b>Syntagmatic</b>	↔	<b>Paradigmatic</b>
<b>Descriptive</b>	↔	<b>Prescriptive</b>
<b>Synchronic</b>	↔	<b>Diachronic</b>

## The Sign

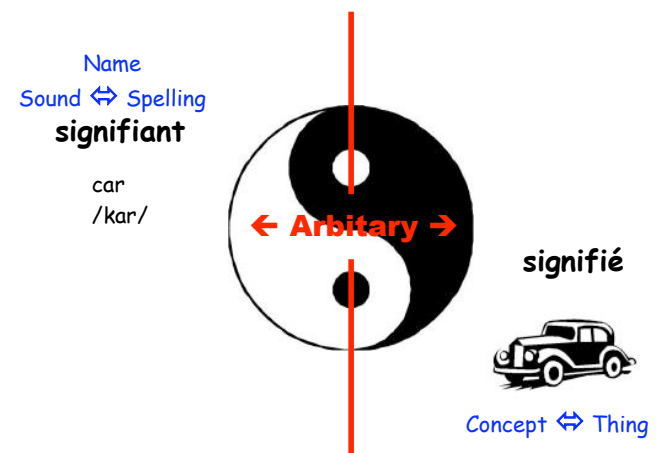

## Arbitrary ↔ Motivated

### Iconicity

Onomatopoeia (DE kikeriki, FR cocorico, angl. cock-a-doodle-doo)

Sound verbs (FR. bruire, mumurer, zozoter, babiller; DE. rauschen, donnern)

Speaking verbs (DE. brüllen, murmeln)

Childrens words (mama)

Reduplication (FR. très très bien, EN. grrrrreat!)

## Arbitrary ↔ Motivated

### Iconicity?

bang, bash, bonk, bump

crack, cramp, crash, crimp, crunch

gleam, glimmer, glisten, glow, glister (Shakespeare)

sleeze, slide, slime, slip, slither, slop, slobber, slump, slush

## Some Dimensons

Signifiant	↔	Signifié (Sausure)
Sense	↔	Reference (Russell)
connotation	↔	denotation
Sinn	↔	Bedeutung (Frege)
Intension	↔	Extension
Langue	↔	Parole
Competence	↔	Performance (Chomsky)
Syntagmatic	↔	Paradigmatic
Descriptive	↔	Prescriptive
Synchronic	↔	Diachronic

## Some Dimensons

Signifiant	↔	Signifié (Sausure)
Sense	↔	Reference (Russell)
connotation	↔	denotation
Sinn	↔	Bedeutung (Frege)
Intension	↔	Extension
Langue	↔	Parole
Competence	↔	Performance (Chomsky)
Syntagmatic	↔	Paradigmatic
Descriptive	↔	Prescriptive
Synchronic	↔	Diachronic

## The Sign



signifié



Concept ↔ Thing

Intension ↔ Extension  
 Connotation ↔ Denotation  
 Meaning, Sense ↔ Reference

## Intension and Extension

Meaning and Reference

In defining general terms, logicians are careful to distinguish between the **extension** of a term (which is the collection of objects to which a term applies) and its **intension** (or the shared attributes of those objects). Though the **extension** of a term is determined by its **intension**, the opposite is not true. Moreover, when attributes are added to the **intension** of a term, the **intension** increases—though the opposite is true of the **extension**. Terms may, therefore, have **intension** but no **extension**.

## Properties $\leftrightarrow$ Objects

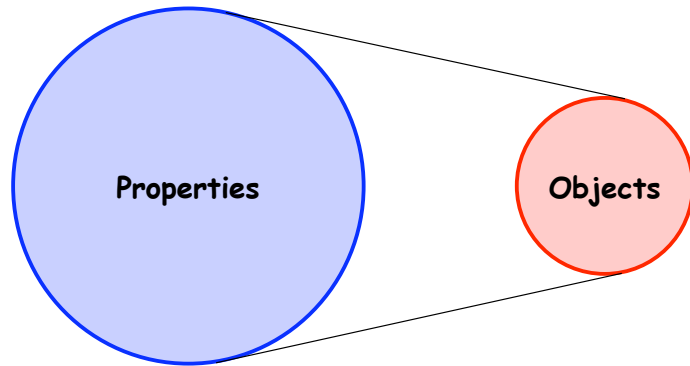

Martin Kay

Translation—Meaning

13

## Properties $\leftrightarrow$ Objects

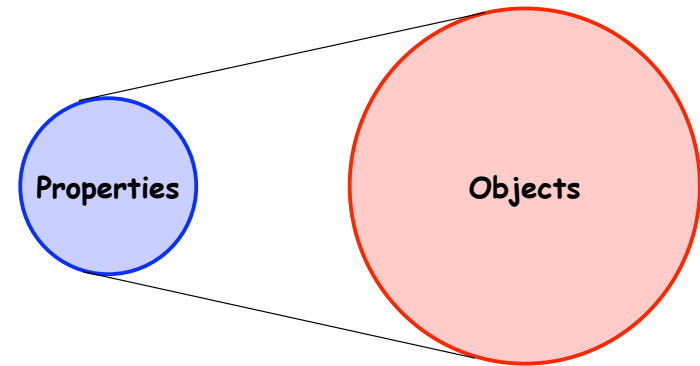

Properties are constraints

Martin Kay

Translation—Meaning

14

## No Extension

Unicorn

The square root of -1

four legged biped

The present king of France

It is by virtue of their intension that you can tell that they have no extension. c.f.

The set of all sets that do not contain themselves

Is nonselfpredicability selfpredicable?

Martin Kay

Translation—Meaning

15

## Multiple Intensions $\Rightarrow$ Same Extension

- The morning star  $\leftrightarrow$  evening star
- Caesar  $\leftrightarrow$  Cicero
- The composer of "The Magic Flute"  $\leftrightarrow$  "The composer of "Don Giovanni"

Martin Kay

Translation—Meaning

16

## Meaning through

- Ostensive definition
- Formal definition
- Family Resemblance

## Ostensive Definition

Defining a term by pointing to a exemplary or paradigmatic referent. I say to my Spanish friend, "What is a 'lápiz'?"; he points to a pencil and says, "lápiz." That would be an ostensive definition of 'lápiz'.



Referent → Meaning  
Translation—Meaning

## A Simple Model

- The world is made up of *things*—objects, properties, actions, fantasies, parts and sets of other things
- Things have *names*.

## The Semiotic Grid

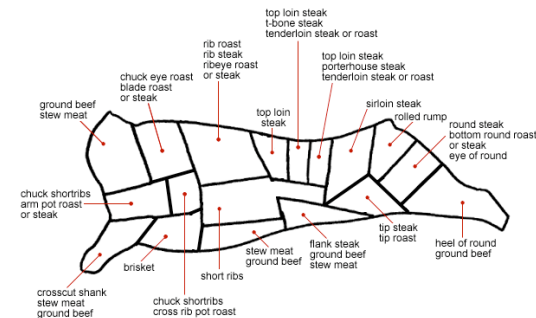

# Terminology

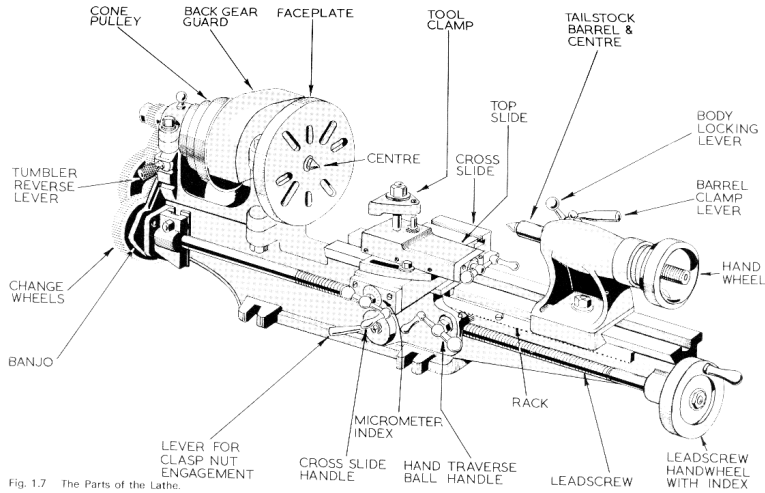

Fig. 1.7 The Parts of the Lathe.

# The Semantic Grid

		English	Japanese		
cook	bake		YAKU	↑ heat only	
	toast				
	roast				
	broil	barbecue		IRU	↓ oil cooking
		grill		ABURU	
	fry	stir-fry		ITAMERU	↓ oil cooking
		sauté			
		deep-fry		AGERU	
	boil	French-fry		FRY NI SURU	↓ water cooking
		braise		TEMPURA NI SURU	
simmer		stew		ITAMENI NI SURU	
		poach		NIRU	
boil			TAKU		
steam		YUDERU			
			MUSU, FU	↓	

Tetsuya Kunihiro

# The Semantic grid

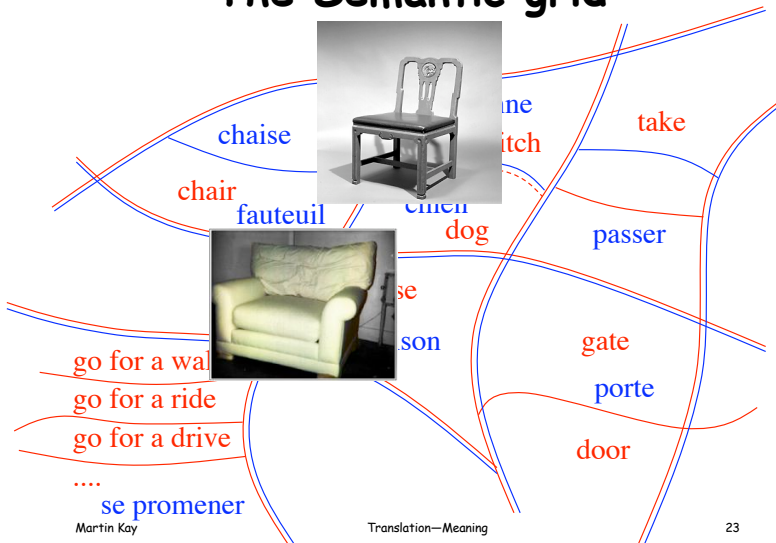

# Holes in the Grid

## Different world

Two no trumps	happy hour
Alimony	value-added tax
An end run	nut
n-th floor	n pièces

## Reasonable syntactic alternative (rephrasing)

clockwise  
 dans le sens des aiguilles d'une montre  
 der Zug wird voraussichtlich zehn Minuten Verspätung haben  
 the train will probably be about ten minutes late  
 the train is expected to be about ten minutes late

## Definition

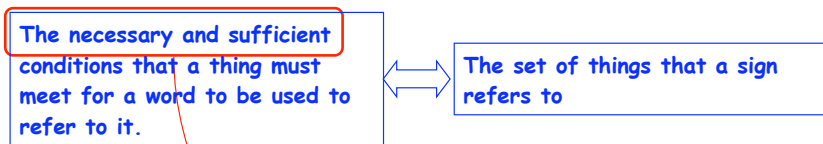

To be in the denotation of the term, it

1. must meet these conditions;
2. It need meet no others

## Definition

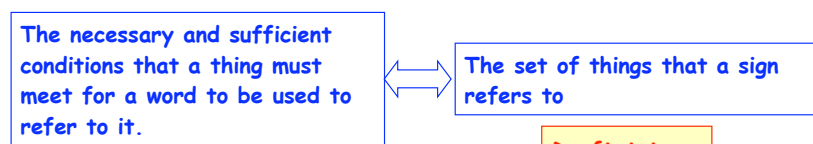

Definitions

**Bachelor:** A male human being who has never been married.

**Chair:** An article of furniture intended to sitting on and with a back to lean against

**Cup:** Container from which liquids are intended to be drunk

**Door:** A sheet of material attached by hinges to the side of a rectangular opening in a wall so that it may swing open to allow entry to, and exit from, the room, or swing closed to fill the opening.

## Definition

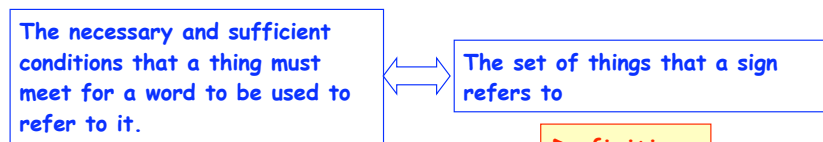

Definitions

**Bachelor:** A male human being who has never been married.

- A newborn baby?
- The pope?
- A man who has lived with the same woman for forty years, who has had several children with her, and whose finances are interwoven with hers?

## Definition

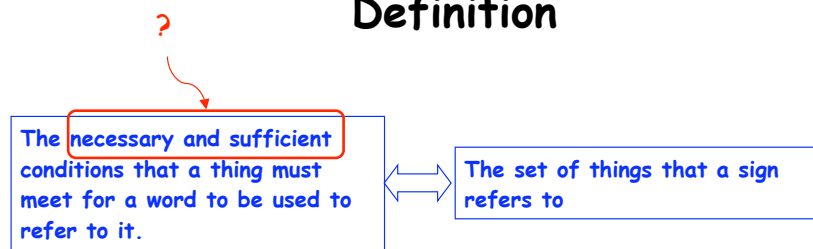

**Bachelor:** A male human being who has never been married but was eligible to be

## Formal Definition is

- Hard
- Context Dependent
- Sometimes impossible

Bachelor    Roast  
Game        Can opener  
Cup          Circle  
Trot         Alimony  
Chair        Left  
Door

## Formal Definition

need not be restricted to  
*intrinsic* properties. c.f.

intended to ...  
regarded as ...  
with the aim of ...

## Relational Approaches

- Synonymy
- Similarity
- Heteronymy/Incompatibility  
—blue green yellow
- Antonymy
- Hyponomy
- Meronymy
- Complementarity/contradiction  
—succeed/fail

Can be quite precise!

## Decompositional Approaches

kill(x) = cause(die(x))  
give(x, y, z) = cause(x, have(y, z))  
get(x, y) = begin(have(x, y))  
sell(x, a, z) = buy(z, a, y) = give(x, a, z) &  
give(z, b, y) & money(b)

Generally too precise!



It is one thing for there to be conditions and another to be able to formulate them satisfactorily

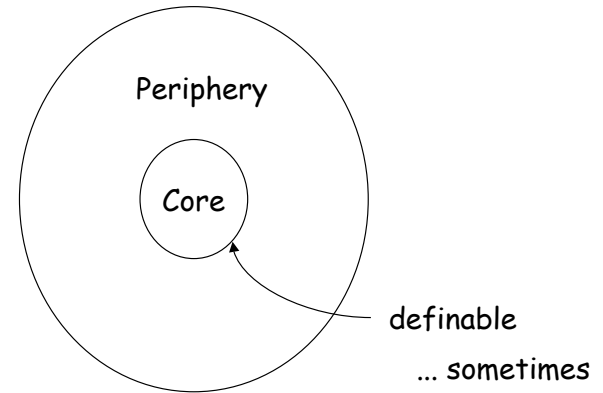
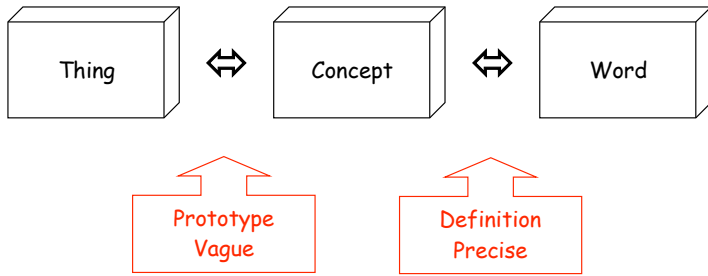

## How many meanings

to have idea  
 give feeling  
 get cold  
 my reason for ...  
 Mary's time to ...  
 the intention  
 protection from ...  
 connection to ...  
 car  
 \$15



*How many meanings does "have" have.*

## Wittgenstein

Learning from ostensive definition

Someone coming into a strange country will sometimes learn the language of the inhabitants from ostensive definitions that they give him; and he will often have to 'guess' the meaning of these definitions; and will guess sometimes right, sometimes wrong

Augustine describes the learning of human language as if the child came into a strange country and did not understand the language of the country; that is, as if it already had a language, only not this one. Or again: as if the child could already think, only not yet speak. And "think" would here mean something like "talk to itself".

# Family Resemblance

(Wittgenstein)

What is the meaning of the word 'game'?

Is it competition? skill? exercise?

There is no fixed meaning

A 'family of characteristics'

'Meaning is use'

'Concept with hazy edges'

# Delagrave (1895)

Le nom n'a pas pour fonction de définir la chose, mais seulement d'en éveiller l'image. Et, à cet effet, le moindre signe, le plus imparfait, le plus incomplet suffit, du moment qu'il est établi, entre les gens parlant la même langue, qu'un rapport existe entre le signe et la chose signifiée.

# School

1. Several local schools were badly damaged by the tornado.
2. Many think that American children should spend more time in school.
3. Sally and Joey went to the game to root for their school.
4. In some parts of the world it is not uncommon for children to leave school before the age of 13.
4. In some parts of the world it is not uncommon for children to leave school before the 3 in the afternoon.
5. Hilary thinks her school in Germany is much harder than the one in Uzbekistan.
6. After the game, the whole school gathered to celebrate the victory.

# School

7. The school is considering changes in the code on academic honesty.
8. Rachel is being home schooled, so she goes to school at home.
9. Joey stopped going to school when he found a job as a rock star.
10. I can't make it for lunch. I have school from 10 until 4 on Wednesday.
11. Snoop considers himself one of the old school rappers.
12. The Flemish school was very influential in the 15th century.

# Line

1. It's hard to draw a straight line without a ruler.
2. There's a thin line between love and hate.
3. The line to get in was really really long.
4. When I asked her out, she gave me some line about having to clean her apartment that night.
5. There are 14 lines in a sonnet.
6. What's the official line on depleted uranium from the administration?
7. Drop me a line some time.

Martin Key

Translation—Meaning

41

# Line

8. They had been talking for about five minutes when suddenly the line went dead.
9. Zelda had a hard time keeping the kids in line.
10. Looks like we've come to the end of the end of the line.
11. You can take the green line to L'Enfant Plaza.
12. We're on the front lines here in the war against drugs.
13. What's the line on the game tonight?
14. Our credibility may be on the line here.
15. They hung the washing out on the line.

Martin Key

Translation—Meaning

42

# Cups and Mugs



Celadon with Bucksin

Martin Key

Translation—Meaning

43

# Efficient Communication

The participants in a conversation are attempting to follow parallel paths through semantic space.

1. Messages need be sent only to correct the course of the other, or to verify ones own.
2. All messages that would achieve this effect are equivalent and there is efficiency in choosing a short one.

Martin Key

Translation—Meaning

44

## Preserve the Meaning?

- Wagen hält / arrêt demandé
- Sonerfahrt / Not in Service
- Nicht Raucher / No Smoking
- Zahlen / pagare / l'addition
- Ein/ausfahrt freihalten / Do not block driveway
- forte / piano / allegro / largo
- Floor numbers
- Left/right when talking about driving
- Bienenhonig
- sí / no

## Preserve the Meaning?

- pour indiquer le bon fonctionnement ⇒ to show that they are working properly.
- His clever brother was always in his light ⇒  
Er stand immer im Schatten seines klugen Bruders
- der Zug wird voraussichtlich zehn Minuten Verspätung haben
  - the train will probably be about ten minutes late
  - the train is expected to be about ten minutes late

## Preserve the Meaning?

- It's not Kosher
- It's Greek to me
- Ne quittez pas
  - Don't stop
  - Don't hang up
  - Hang on
  - Just a moment
  - one moment please
  - please hold



Est ce que c'est ta cousine?

Non, je n'ai pas de cousine

female  
Is that your cousin?  
^

female  
No, I don't have a cousin  
^

⇒ I *do* have a male cousin!

Is that woman your cousin?

Je n'ai ni cousin ni cousine



Est ce que c'est ta cousine?

<sup>female</sup>  
Is that your cousin?  
^

⇒ I *do* have a male cousin!

Non, j'e n'ai pas de cousine

<sup>female</sup>  
No, I don't have a cousin  
<sup>girl</sup>

Is that ~~woman~~ your cousin?  
^

## Translation Word Meaning

*The End*